

Antec

# CONSTELLATION SERIES

## C88 ALUMINUM WHITE



### FULL-VIEW PC CASE SEAMLESS EDGE ON FRONT & SIDE PANEL WITH EXOTIC ALUMINUM

Glass panels employ unique 45° beveling technique that breaks the barrier between glasses, providing an uninterrupted and ultra-transparent view. Right side of front is made of aluminum that could be seamlessly integrated into your interior design style.



▲ 45° Glass Beveling

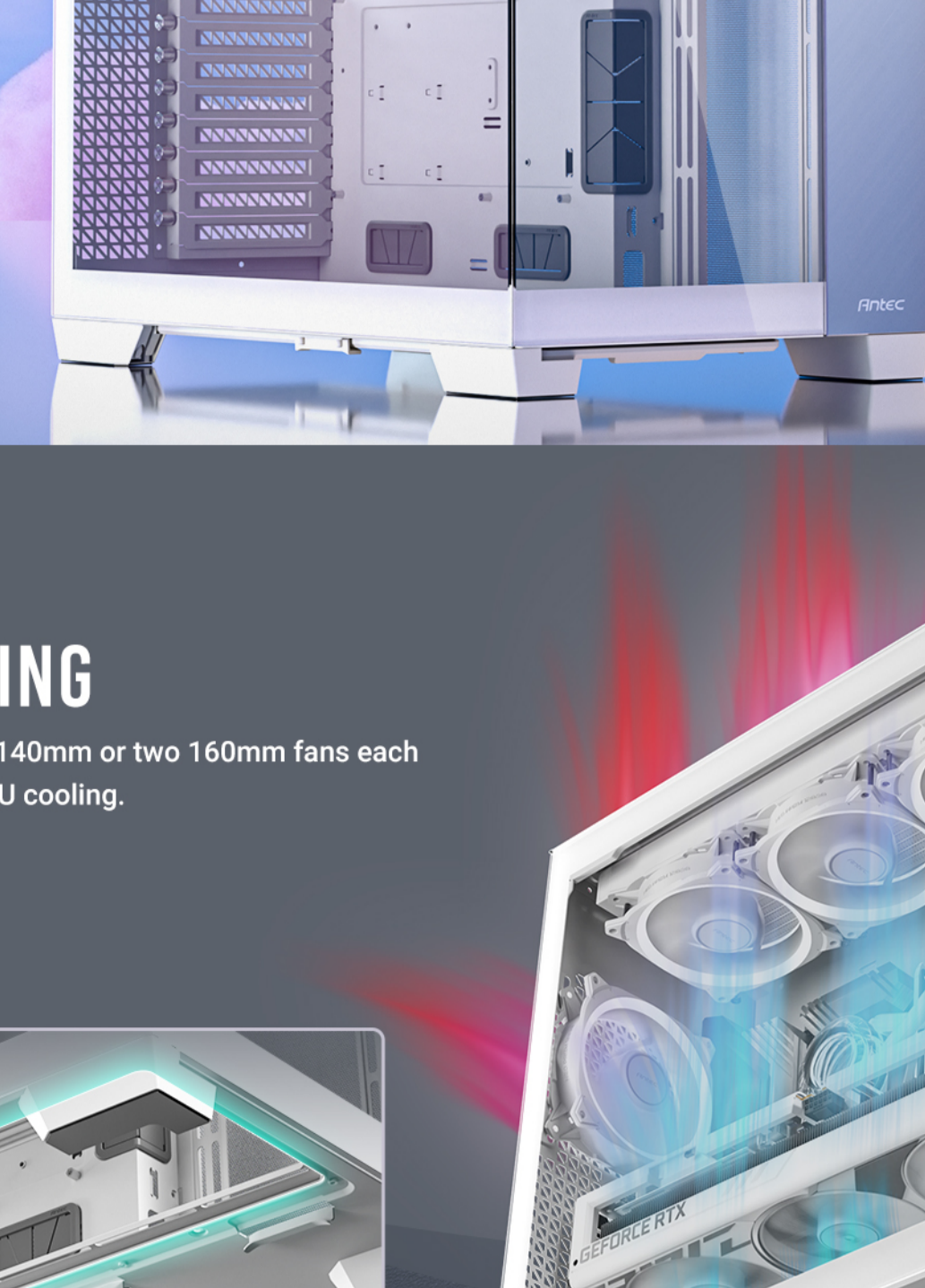

#### AIRFLOW

### VERTICAL COOLING

Can accommodate three 120mm/140mm or two 160mm fans each on top and bottom for efficient GPU cooling.

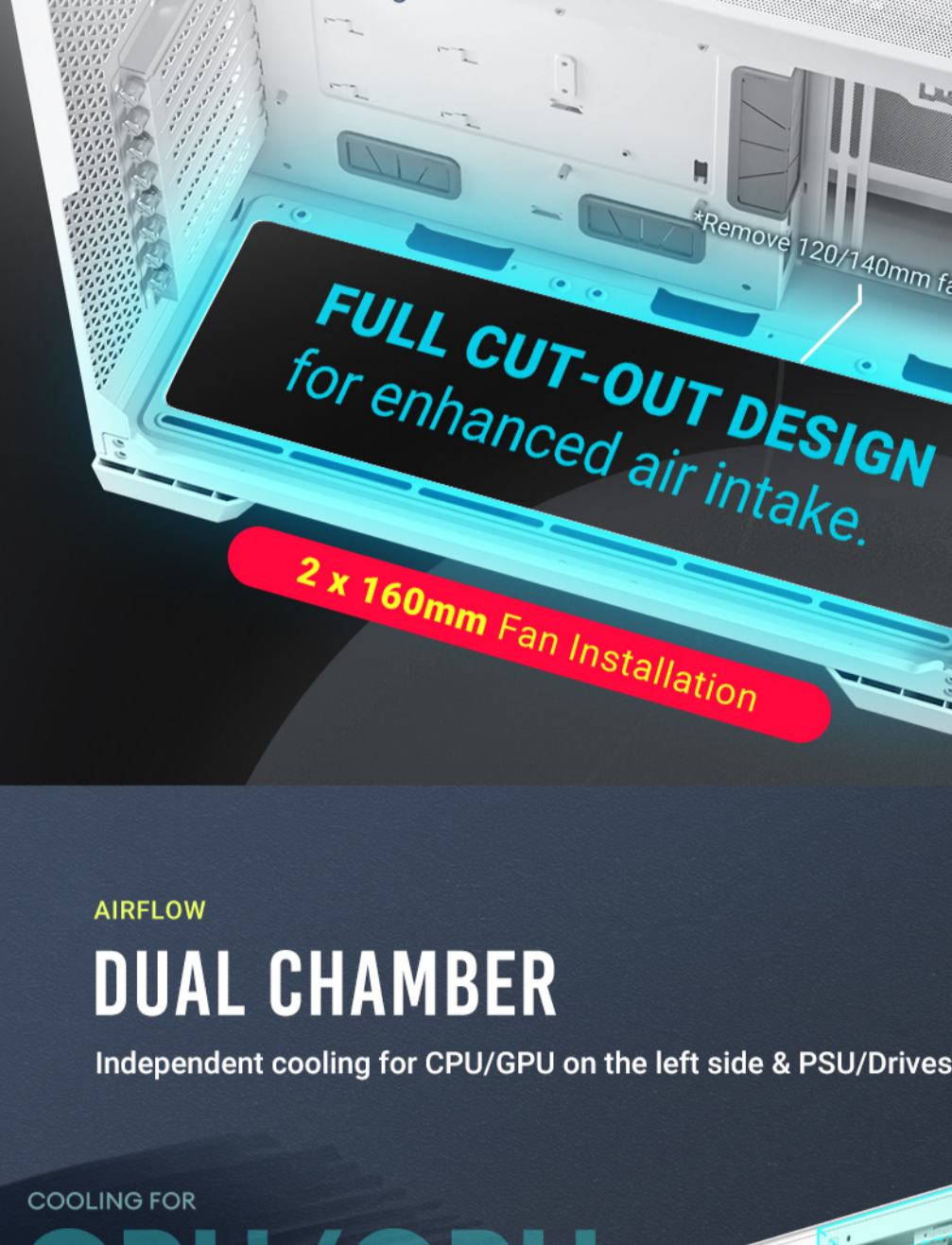

▲ Full cut-out design for enhanced air intake

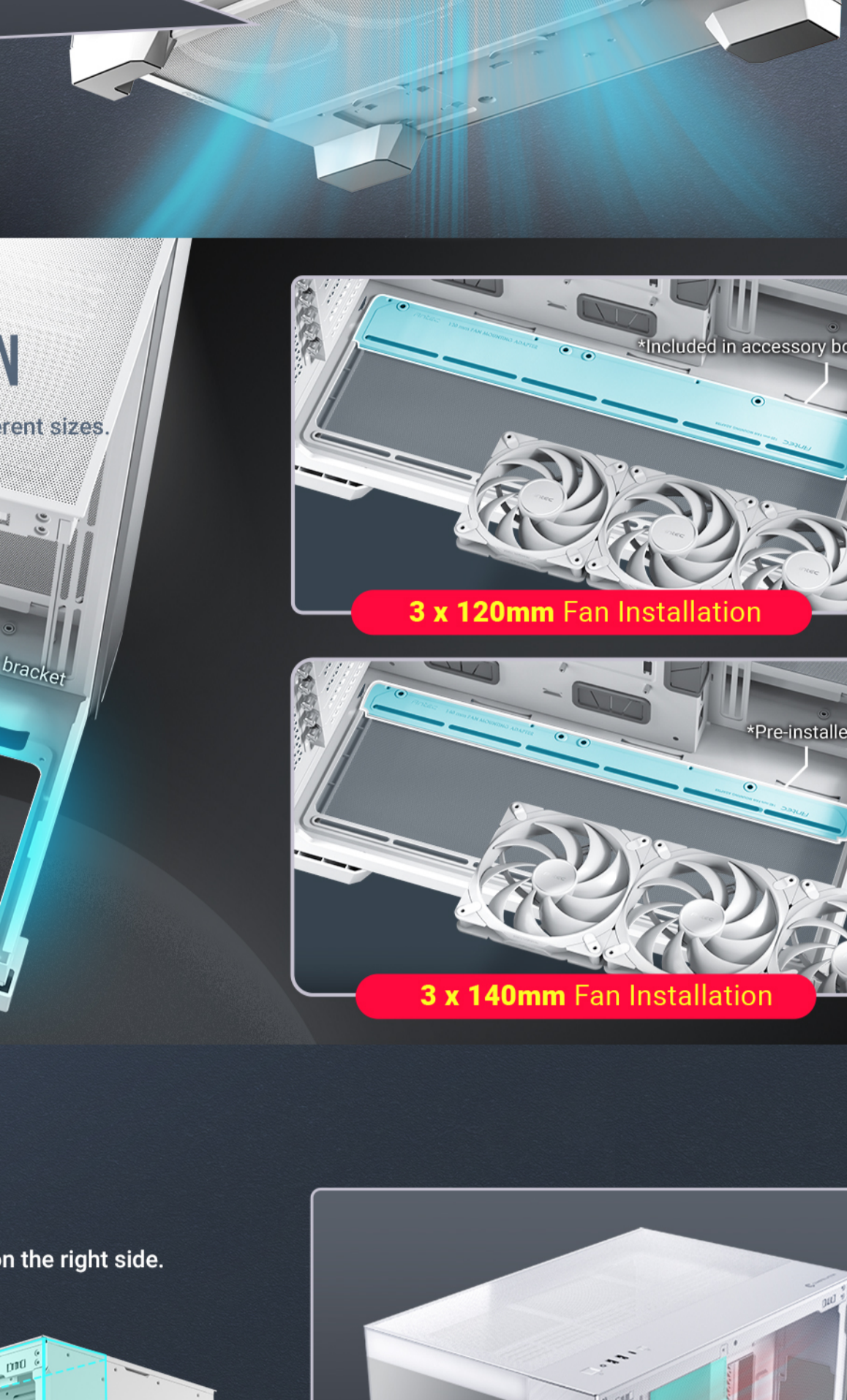

#### THREE-WAY FAN BRACKET

Comes with interchangeable fan brackets to cater to fans of different sizes.



**FULL CUT-OUT DESIGN** for enhanced air intake.  
2 x 160mm Fan Installation

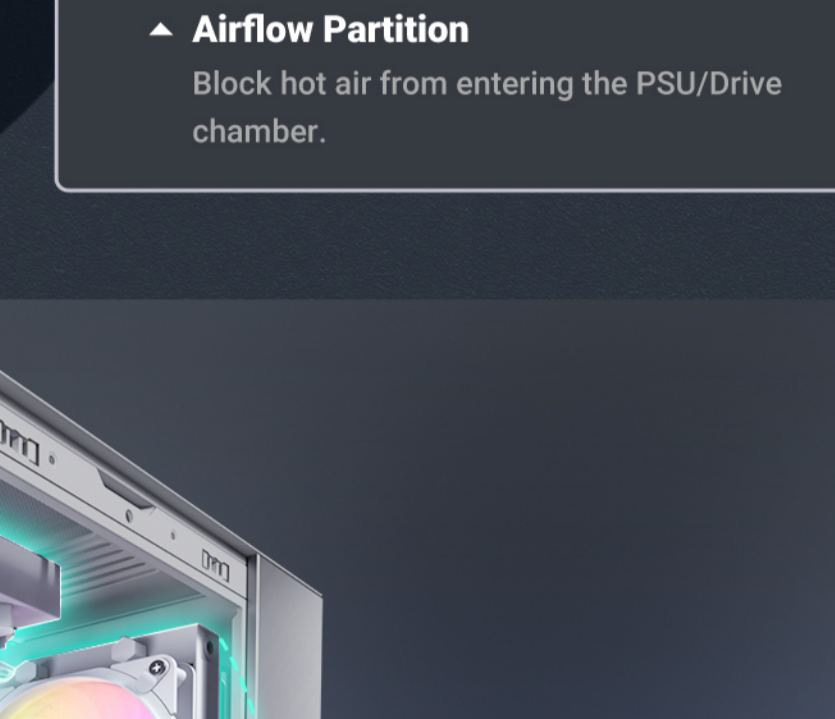

3 x 120mm Fan Installation

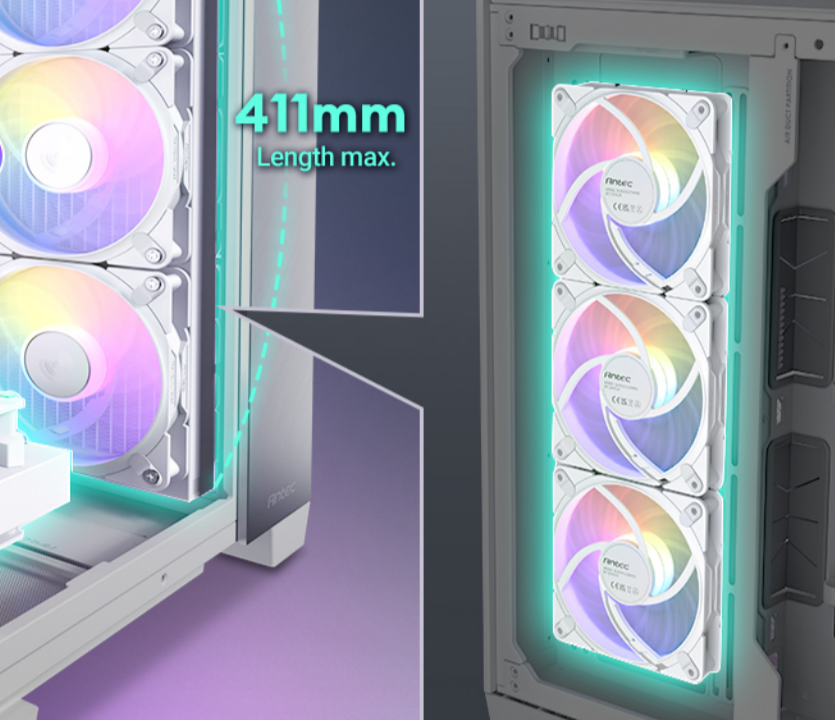

3 x 140mm Fan Installation

#### AIRFLOW

### DUAL CHAMBER

Independent cooling for CPU/GPU on the left side & PSU/Drives on the right side.

#### COOLING FOR CPU/GPU

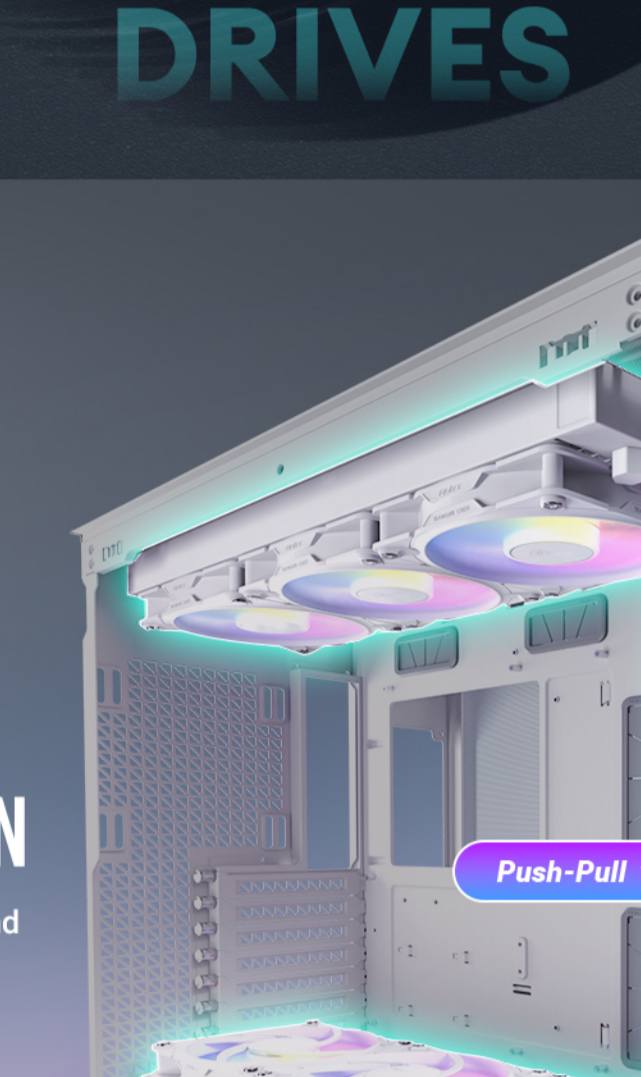

#### COOLING FOR PSU/DRIVES

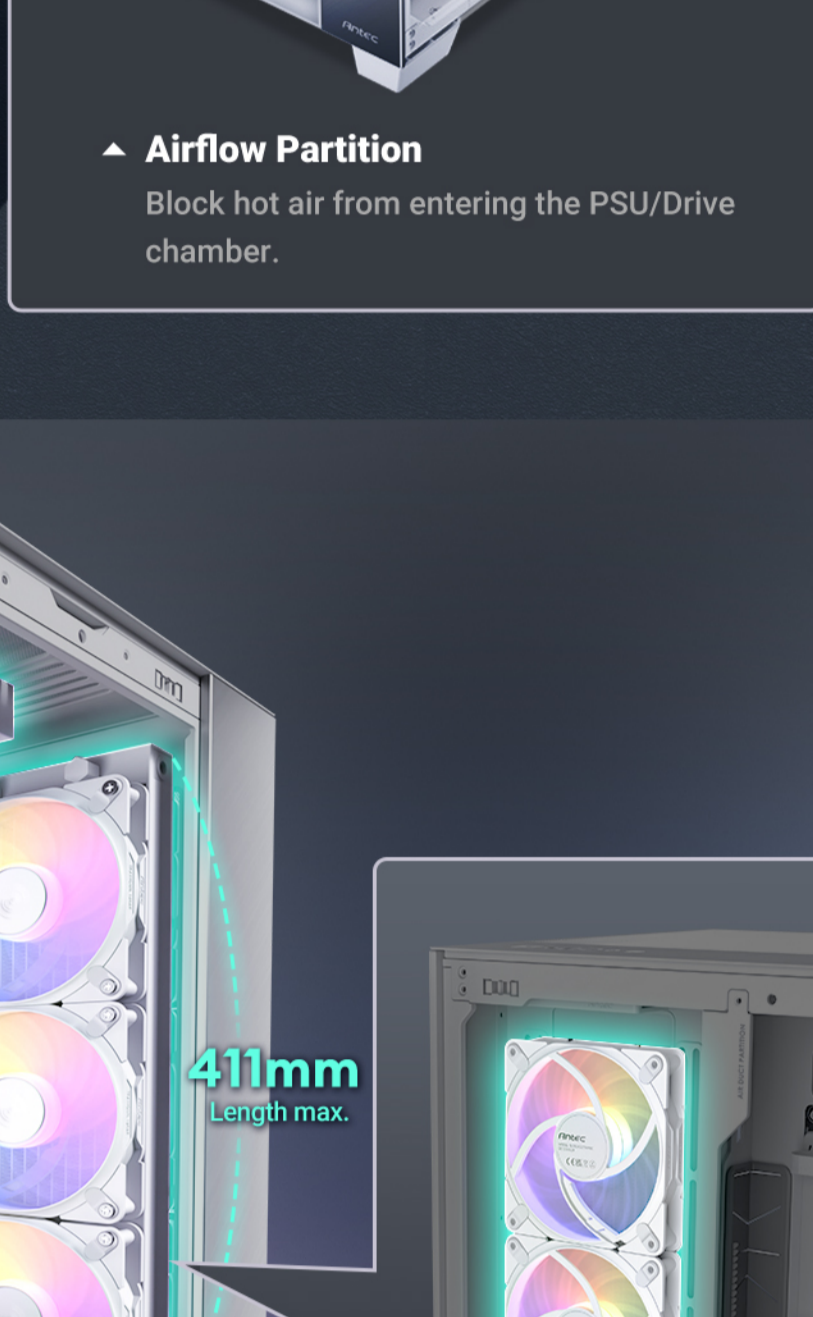

▲ Airflow Partition Block hot air from entering the PSU/Drive chamber.

#### EXTREMELY COOL

### BEST COOLING DESIGN

Support 3 x 360mm radiators on top, bottom, and side simultaneously for liquid cooling.

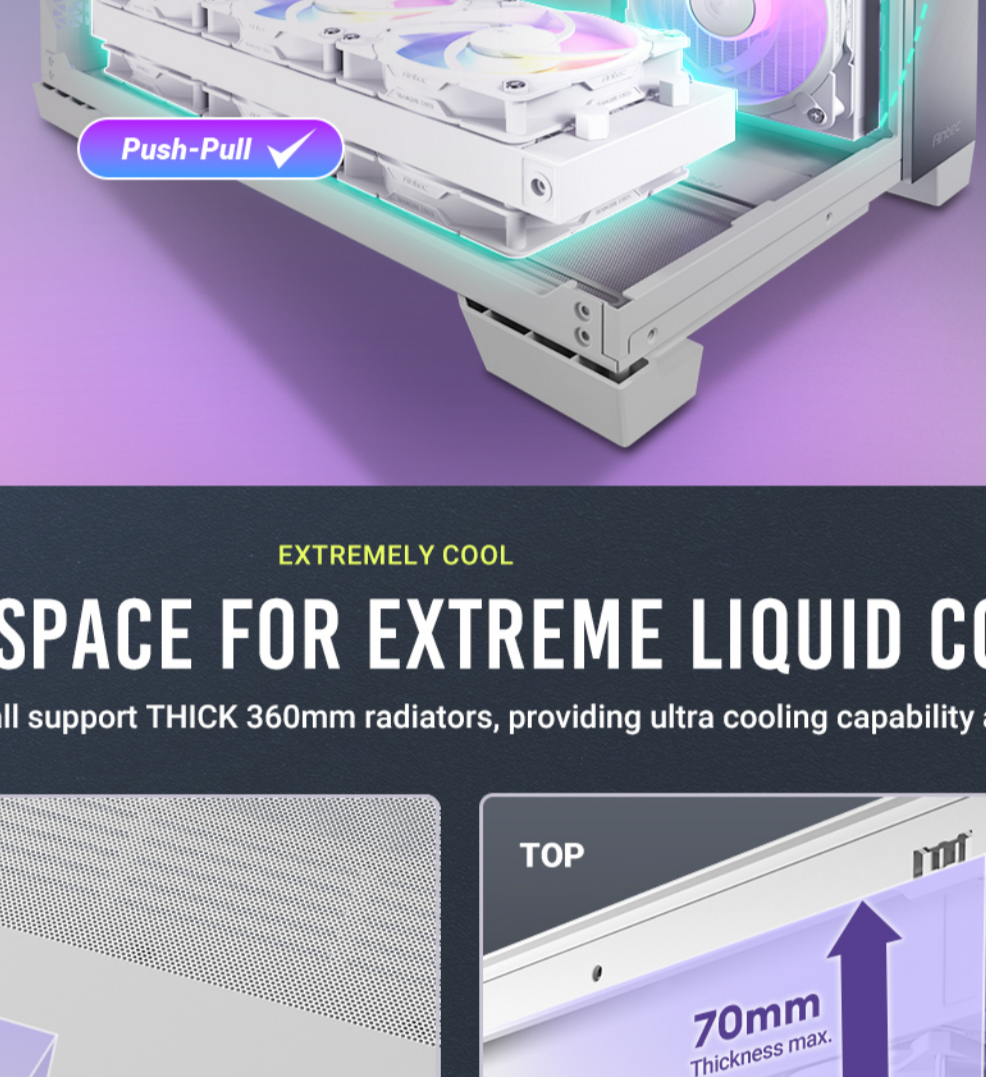

Push-Pull ✓



411mm Length max.

#### EXTREMELY COOL

### CAVERNOUS SPACE FOR EXTREME LIQUID COOLING

Top, bottom and right side all support THICK 360mm radiators, providing ultra cooling capability and efficiency.

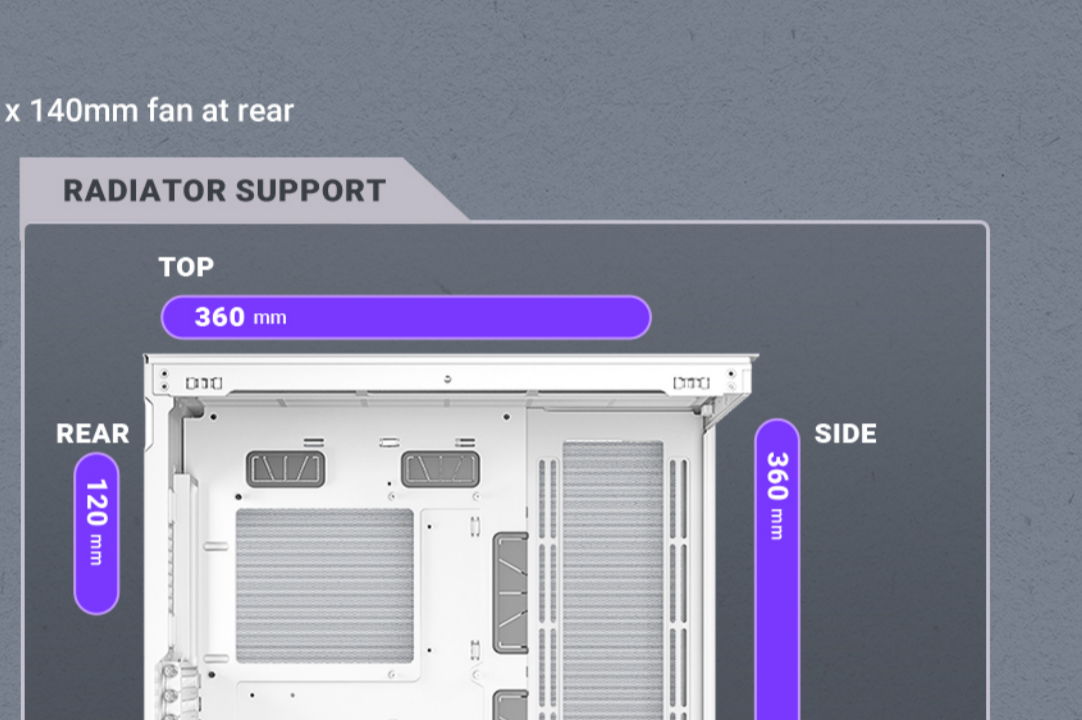
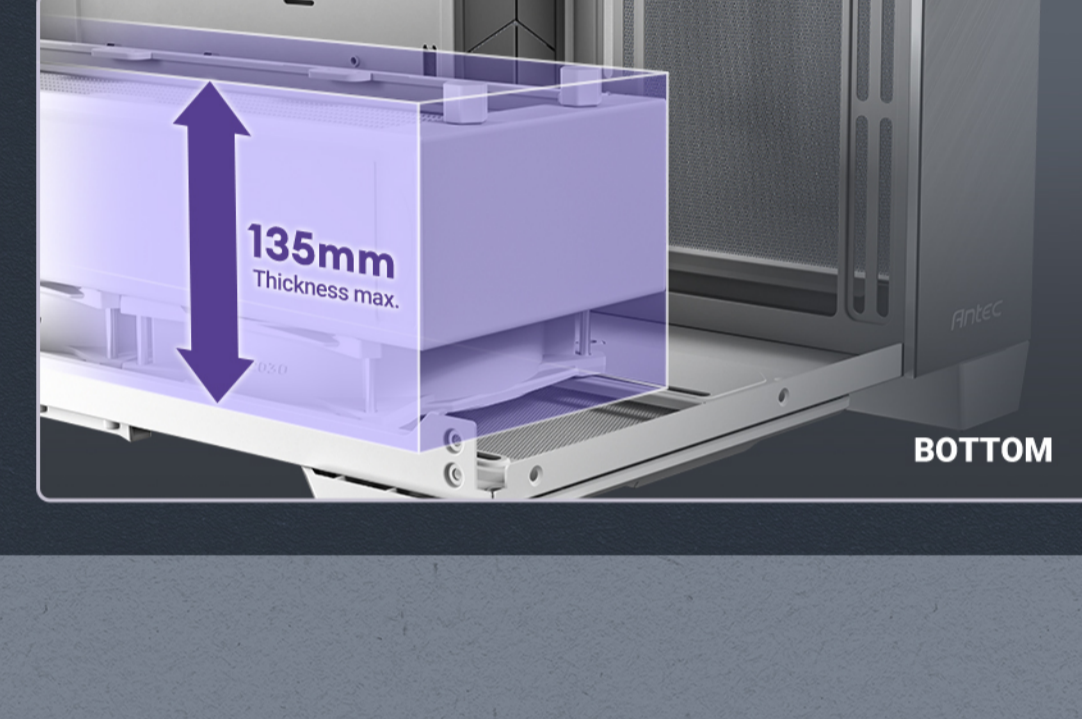
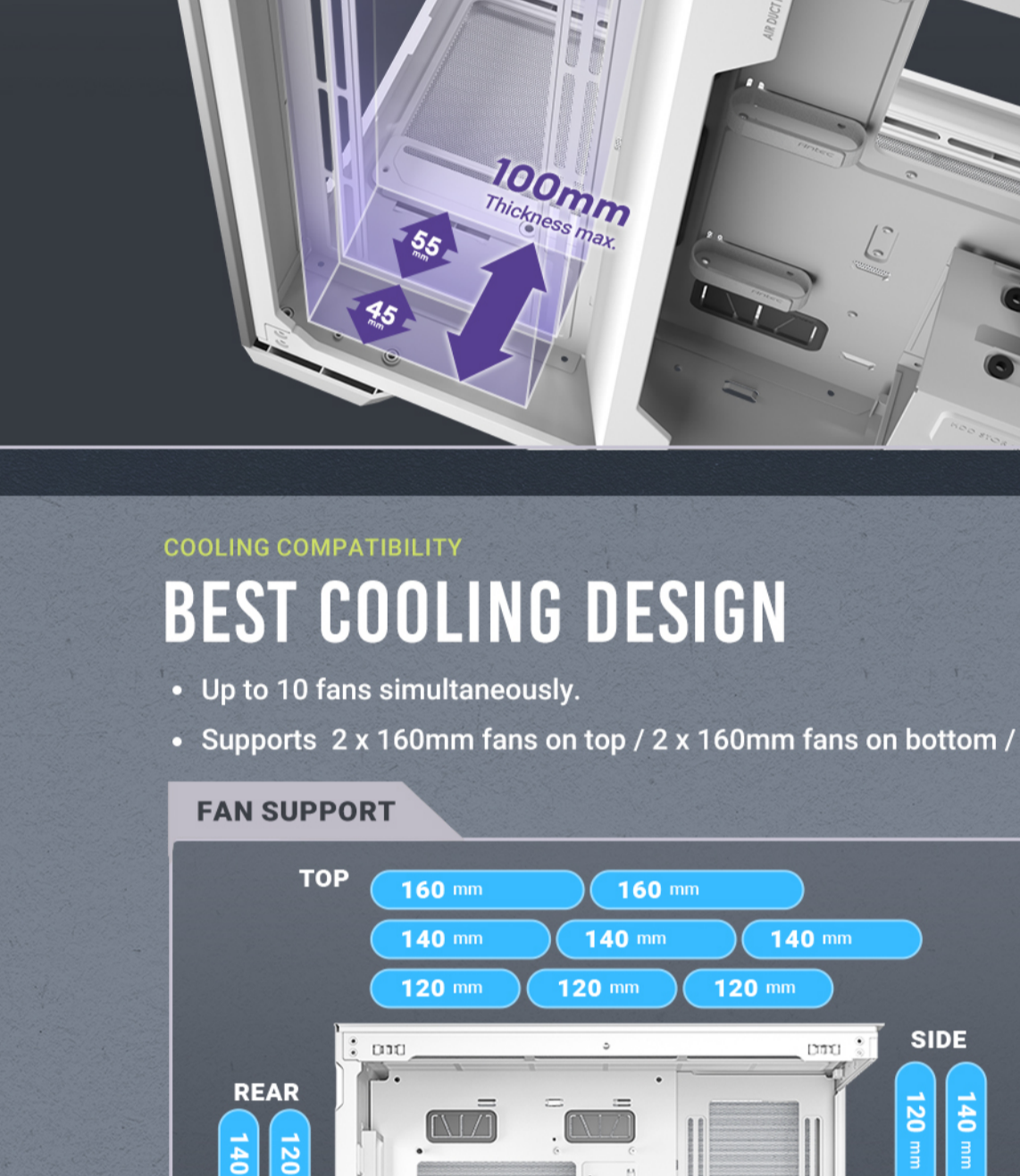

#### COOLING COMPATIBILITY

### BEST COOLING DESIGN

- Up to 10 fans simultaneously.
- Supports 2 x 160mm fans on top / 2 x 160mm fans on bottom / 1 x 140mm fan at rear

#### FAN SUPPORT



#### RADIATOR SUPPORT



#### DUSTPROOF DESIGN

### AIR INTAKE AND DUST FILTER

- ▲ TOP | Full mesh panel
- ▲ RIGHT SIDE | Full mesh panel
- ▲ BOTTOM | Full-sized pull-out dust filter

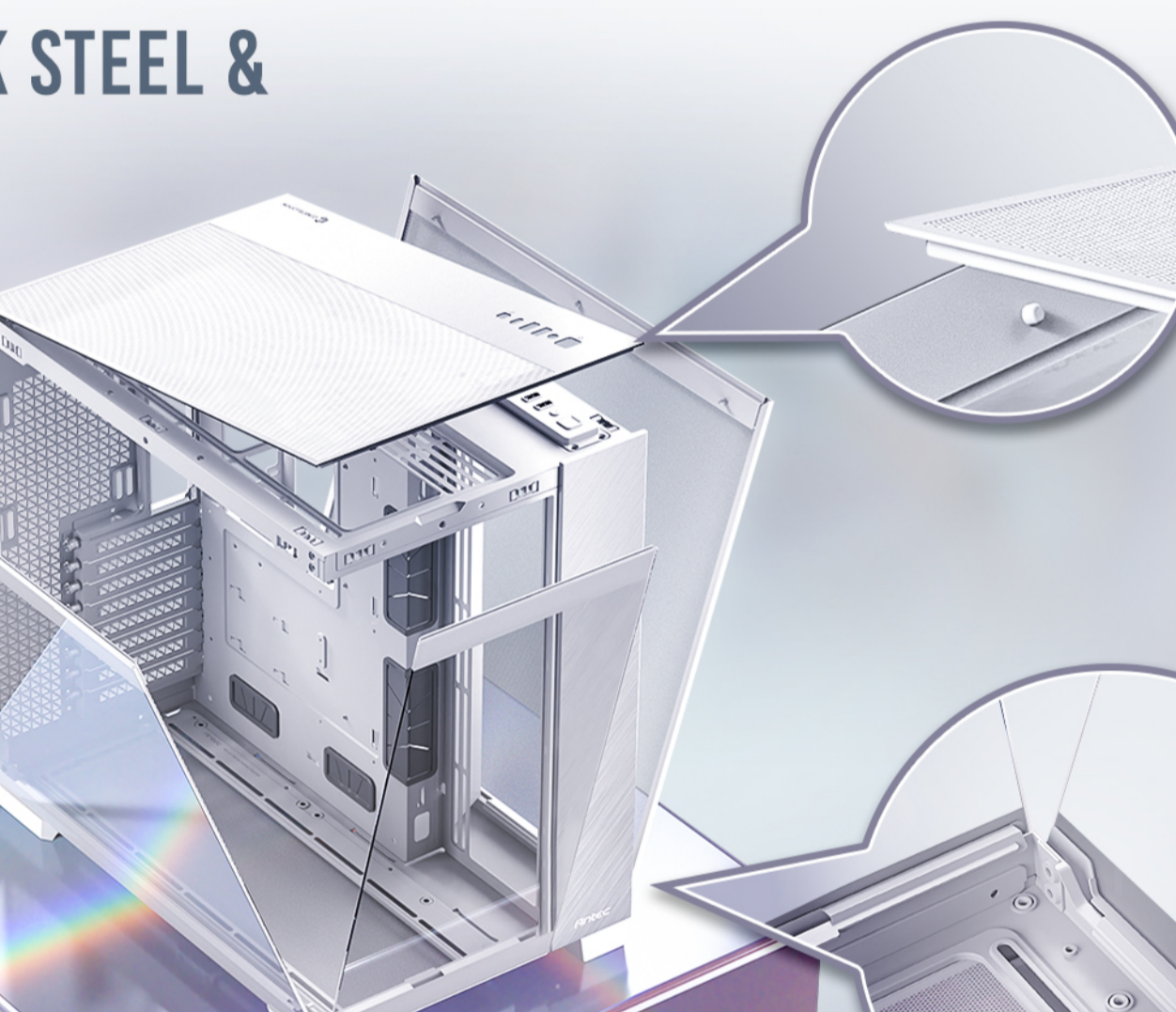

#### IMPRESSIVE STRUCTURE

### 0.8MM + 1.0MM THICK STEEL & TOOL-FREE DESIGN

The ultra robust 0.8mm & 1mm steel brings unwavering protection, and the tool-free quick-release panels on the front, top and sides make the assembly and cleaning of components simplified than ever.

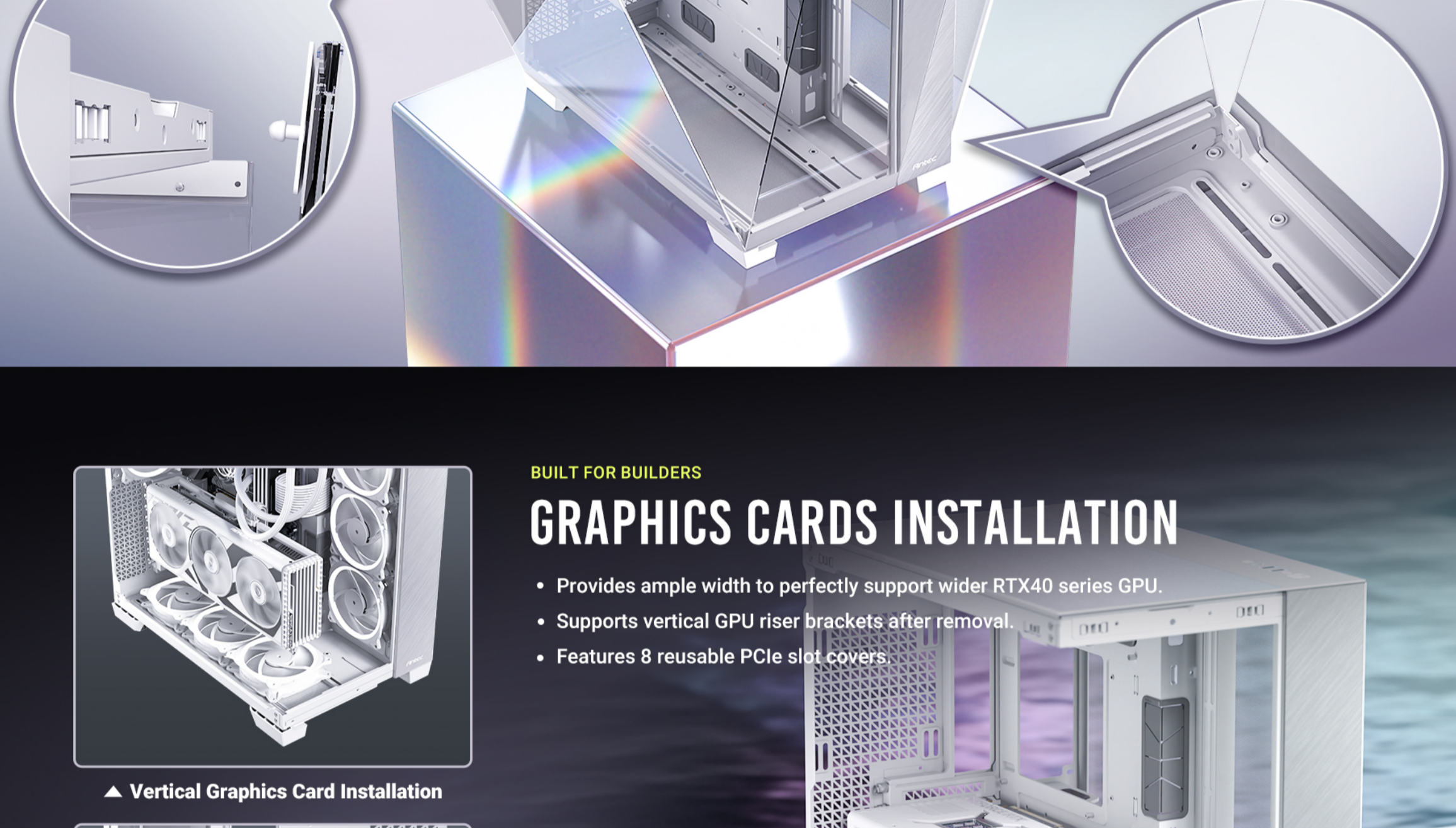

#### BUILT FOR BUILDERS

### GRAPHICS CARDS INSTALLATION

- Provides ample width to perfectly support wider RTX40 series GPU.
- Supports vertical GPU riser brackets after removal.
- Features 8 reusable PCIe slot covers.



▲ Vertical Graphics Card Installation



▲ 8 \* Fully Open PCIe Slots



#### POWERFUL COMPATIBILITY

### POWER SUPPLY INSTALLATION

- Stylish PSU bracket with rubber pad to prevent scratch
- Vast room to house power supplies up to 210mm in length
- Support side-interface power supplies



#### EVERYTHING ORGANIZED

### CABLE MANAGEMENT

- ▲ Interior velcro strap \*4
- ▲ Rear velcro strap \*2
- ▲ Cable routing rubber grommet \*6

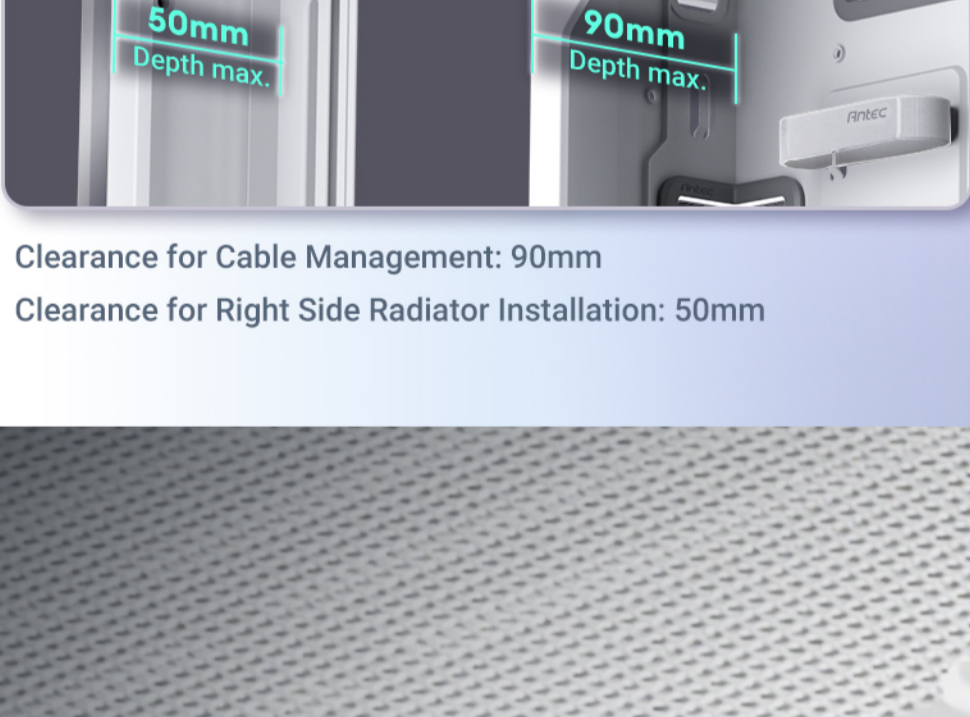

Clearance for Cable Management: 90mm  
Clearance for Right Side Radiator Int Installation: 50mm



### I/O PANEL

- Mainstream Type-C (10Gbps) port for high-speed transmission
- Dust plugs for dust prevention
- Mic/Audio 2-in-1 port

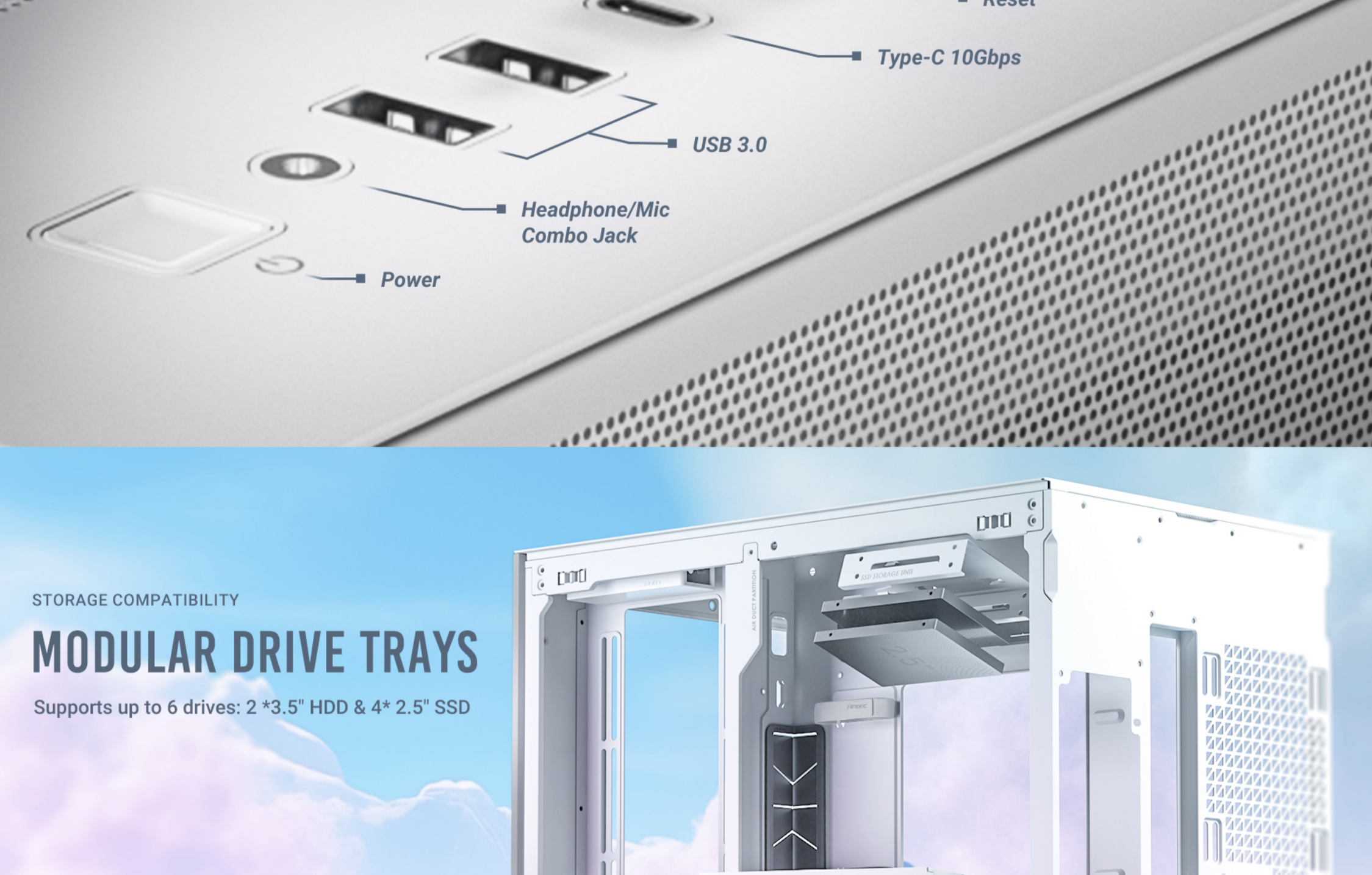

#### STORAGE COMPATIBILITY

### MODULAR DRIVE TRAYS

Supports up to 6 drives: 2 \* 3.5" HDD & 4 \* 2.5" SSD

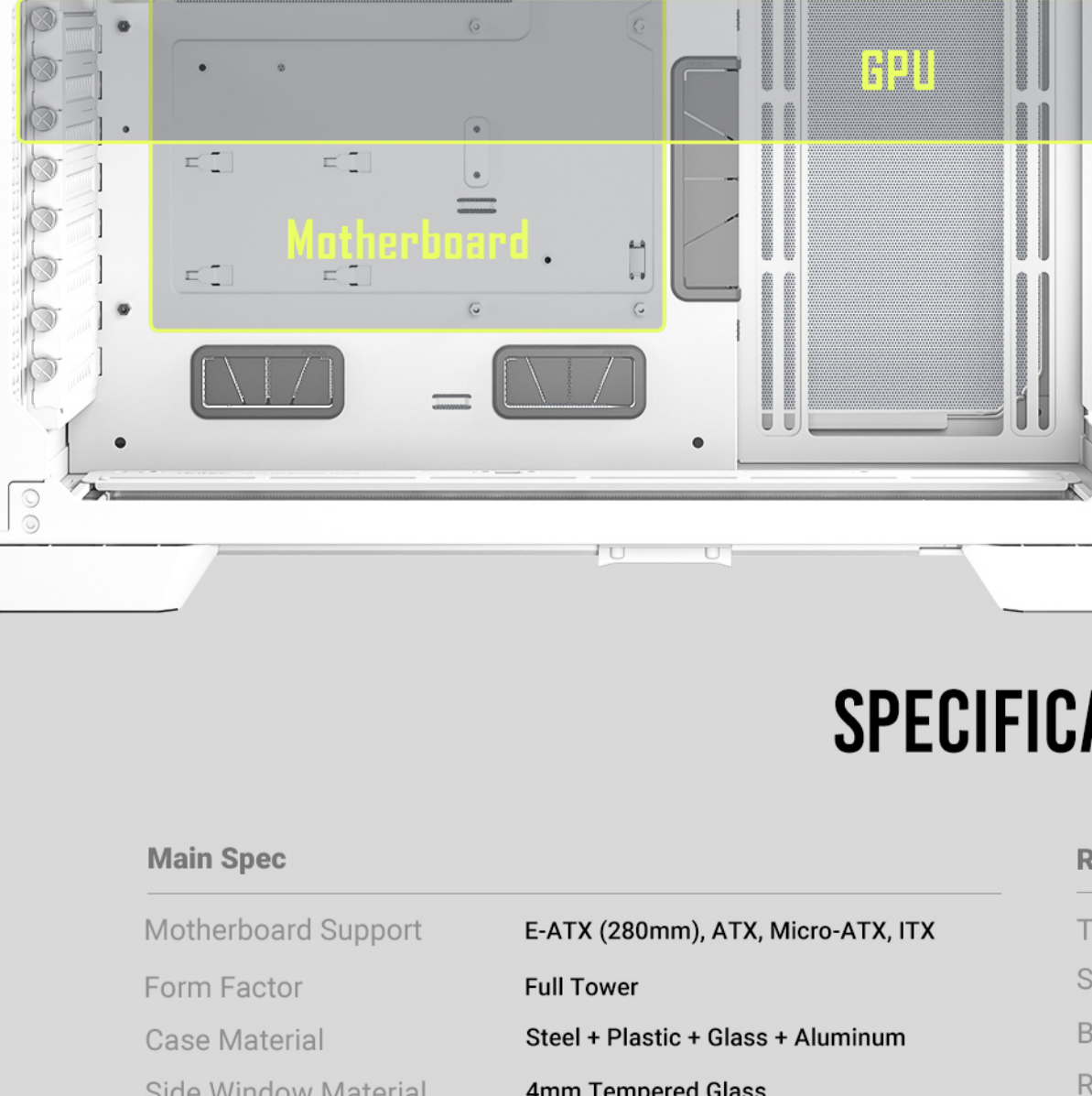

#### CASE COMPATIBILITY

### EXTENSIVE INTERIOR

- Motherboard support E-ATX(≤280mm), ATX, Micro-ATX, ITX
- CPU cooler max height ≤175mm
- GPU max length ≤440mm
- Power Supply max length ≤210mm

## SPECIFICATION

#### Main Spec

Motherboard Support	E-ATX (280mm), ATX, Micro-ATX, ITX
Form Factor	Full Tower
Case Material	Steel + Plastic + Glass + Aluminum
Side Window Material	4mm Tempered Glass
I/O Ports	Power, Reset, USB 3.0 x 2, Type-C 10Gbps x 1, Headphone / Mic Combo Jack
Case Dimensions (DxWxH)	464 x 303 x 476mm
Box Dimensions (DxWxH)	549 x 400 x 553mm

#### Compatibility & Clearances

CPU Cooler Max Height	≤ 175mm
GPU Max Length	≤ 440mm
Power Supply Max Length (Without cable)	≤ 210mm
Cable Routing Space	≤ 90mm

#### Fan Support

Top	120mm x 3 / 140mm x 3 / 160mm x 2
Side	120mm x 3 / 140mm x 2
Bottom	120mm x 3 / 140mm x 3 / 160mm x 2
Rear	120mm x 1 / 140mm x 1

#### Radiator Support

Top	Up to 360mm
Side	Up to 360mm
Bottom	Up to 360mm
Rear	Up to 120mm

#### Expansion Slots

Standard	8
----------	---

#### Drive Bays

3.5"	2
2.5"	4

#### General

Dust Filter	Bottom
Net Weight	10.49 kg
Gross Weight	13.43 kg
Warranty	2 years
UPC#	0-761345-10093-9

